



# features of your new air conditioner

---

- **Cool Summer Offer**

On those hot sweltering summer days and long restless nights, there is no better escape from the heat than the cool comforts of home. Your new air conditioner brings an end to exhausting hot summer days and lets you rest. This summer, beat the heat with your own air conditioner.

- **Cost Efficient System**

Your new air conditioner not only provides maximum cooling power in the summer, but can also be an efficient heating method in the winter with the advanced “Heat pump” system. This technology is up to 300% more efficient than electrical heating, so you can further reduce its running cost. Now, meet year-round needs with one air conditioner.

- **A Look for Everywhere**

The elegant and harmonious design gives priority to the esthetics of your space and complements any of your existing interior décor. With its soft color and rounded-edge shape, the new air conditioner adds class to any room. Enjoy what your air conditioner offers both functionally and esthetically.

- **Compact and easy-to-use Cassette type**

Designed to be installed into most types of suspended ceiling, the cassette type air conditioner is ideal for business and commercial accommodations. Fresh cool/warm air can be provided through the controllable 1, 2 or 4 sides of the unit. All functions of the air conditioner will be controlled easily via a remote control.



For easy future reference write the model and serial number down. You will find your model number on the right side of the air conditioner.

Model # \_\_\_\_\_  
Serial # \_\_\_\_\_

# safety information











To prevent electric shock, disconnect the power before servicing, cleaning, and installing the unit.

## SAFETY INFORMATION

Before using your new air conditioner, please read this manual thoroughly to ensure that you know how to safely and efficiently operate the extensive features and functions of your new appliance.

Because the following operating instructions cover various models, the characteristics of your air conditioner may differ slightly from those described in this manual. If you have questions, call your nearest contact center or find help and information online at [www.samsung.com](http://www.samsung.com).

### What the icons and signs in this user manual mean:

 <b>WARNING</b>	Risk of death or serious personal injury.
 <b>CAUTION</b>	Potential risk of personal injury or material damage.
 <b>CAUTION</b>	To reduce the risk of fire, explosion, electric shock, or personal injury when using your air conditioner, follow these basic safety instructions:
	Do NOT attempt.
	Do NOT disassemble.
	Do NOT touch.
	Follow directions carefully.
	Unplug the power plug from the wall socket.
	Make sure the machine is grounded to prevent electric shock.
	Call the contact center for help.
	Recommended instructions or useful information for use.

**These warning signs are here to prevent injury to you and others.**

**Please follow them carefully.**

**After reading this section, keep it in a safe place for future reference.**

## SEVERE WARNING SIGNS

 Do not place the air conditioner near hazardous substances or equipment that releases free flames to avoid fire, explosions or injuries.

- Potential risk of fire hazard or explosion.

**Do not block or place items in front of the air conditioner. Do not step, hang onto, or place heavy items on the air conditioner.**

- Potential risk of personal injury.

**Do not install the outdoor unit at an unstable place or elevated surface where there is potential risk of falling.**

- If the outdoor unit falls, it may cause personal injury or loss of property.

**Any changes or modifications performed not following by the installation manual, failure or damage may occur on the condition. In this case, user will be responsible for all the repair expenses.**

# safety information

---

## SEVERE WARNING SIGNS

---

-  **If any gas or impurities other than R410A refrigerant come into the refrigerant pipe, serious problem may occur and it may cause injury.**

**Do not spray flammable gases such as insecticide near the air conditioner.**

- Potential risk of electric shock, fire or unit malfunction.

**Do not insert anything such as fingers or branches into the air conditioner vents.**

- Keep children away from the air conditioner. Potential risk of personal injury.

**Do not cut the power plug and connect to a different power cable.**

**Never attempt to lengthen the power cable.**

- Potential risk of fire or electric shock.

**Do not yank the power cable and touch the power plug with hands.**

- Potential risk of fire or electric shock.

**Never use a damaged power plug, power cable, or loosened power receptacle.**

- Potential risk of fire or electric shock.

**The electric work must be done by qualified service technician in accordance with the national wiring regulations with rated cables.**

- If the capacity of the power cable is insufficient or electric work have not done properly, electric shock or fire may occur.

**You should connect the power cable into the power cable terminal and fasten it with a clamp.**

-  **Do not connect the air conditioner with heating apparatus or attempt to disassemble, remodel or repair it by yourself.**

- Potential risk of malfunction, electric shock or fire. If repairs are needed, consult the contact center.

**Consult the place of purchase or a contact center to disassemble or reinstall the air conditioner.**

- Potential risk of unit malfunction, water leakage, electric shock, or fire.

-  **Consult the place of purchase or contact center to install the air conditioner.**

- Improper installation carries a risk of unit malfunction, water leakage, electric shock or fire.
- If installing in specialty areas, such as a factory complex or saline coastal area, consult the place of purchase or contact center for specific installation details.

**Install the air conditioner with the support bracket securely fastened to use for an extended period of time.**

- If the air conditioner falls, it may cause personal injury or loss of property.

**If the indoor unit gets wet, turn the power off immediately and call your nearest contact center.**

- Potential risk of fire or electric shock.

**Install an exclusive circuit breaker and short-circuit breaker for the air conditioner.**

- Potential risk of electric shock or fire.

**If the power cable is damaged, the manufacturer or a qualified service technician must replace it.**

**Always make sure that the power supply is compliant with current safety standards. Always install the air conditioner in compliance with current local safety standards.**

**Verify that the voltage and frequency of the power supply comply with the specifications and that the installed power is sufficient to ensure the operation of any other domestic appliance connected to the same electric lines.**

-  **The air conditioner must be installed in accordance with national wiring regulations and safety regulations wherever applicable.**

**Install the supplied cables firmly. Fix them securely so that external force is not exerted to the terminal block.**

- If the connection is loose, heat may generate and cause electric shock or fire.

**Use a rated circuit breaker only.**

- Never use steel wires or copper wires as a circuit breaker. It may cause fire or unit malfunction.

**Use an exclusive power source for the air conditioner.**

- Potential risk of electric shock or fire.

**Do not put undue stress or place heavy object on the power cable.**

**Do not bend the power cable excessively.**

- Potential risk of fire or electric shock.

**Always verify that electric connections (cable entry, section of leads, protections...) are compliant with the electric specifications and with the instructions provided in the wiring scheme.**

**Always verify that all connections comply with the standards applicable to the installation of air conditioners.**

-  **Use a receptacle that has a ground terminal. The receptacle must be used exclusively for the air conditioner.**

- Improper electrical grounding may cause electric shock or fire.

**Be sure to ground the unit. Do not connect the ground wire to gas or water pipes, lighting rods, or telephone grounding lines.**

- If the unit is not properly grounded, electric shock may result.

**Always verify that a suitable grounding connection is available.**

-  **Disconnect the air conditioner from power supply before it is repaired or disassembled.**

## CAUTION SIGNS

-  **Connect the refrigerant tubes first then the electrical lines, when installing the unit. Always disassemble the electric lines before the refrigerant tubes.**

**Verify that the air conditioner is connected to the power supply in accordance with the instructions provided in the wiring diagram included in the manual.**

**The manufacturer shall not be responsible for damage originating from unauthorized changes or the improper connection of electric and hydraulic lines.**

**Failure to comply with these instructions or to comply with the requirements set forth in the "Operating limits" table, included in the manual, and shall immediately invalidate the warranty.**

**Ensure no water gets into the air conditioner.**

- Potential risk or electric shock.

**Turn off the air conditioner using the provided remote control or control accessory (if provided). Do not unplug to turn off the unit (unless there is an immediate danger).**

**Do not open the front grille during operation.**

- Potential risk of electric shock or unit malfunction.

**Cool air should not flow directly towards people, pets, and plants.**

- It is harmful to your health, pets, and plants.

**Do not run the air conditioner for an extended period of time in a room with the door closed or with babies, elderly or disabled people.**

- Open the door or windows to ventilate your room at least once an hour to prevent oxygen shortage.

**Do not drink drain water coming out of the air conditioner.**

- Potential risk of health hazard.

# safety information

---

## CAUTION SIGNS

---



**Do not expose the dust filter to direct sunlight while drying.**

- Strong direct sunlight may deform the dust filter.

**Do not allow children to climb on the air conditioner.**

**Use only rated accessories and install the air conditioner with rated equipments.**

- If you do not use the rated accessories, the air conditioner may drop from its place, water may leak or electric shock or fire may occur.

**Do not use the air conditioner as a cooling precision instrument for food, pets, plants, cosmetics or machinery.**

**Do not give excessive shock to the air conditioner.**

- Potential risk of fire or unit malfunction.

**Do not spray water directly on the air conditioner or use benzene, thinner or alcohol to clean the surface of the unit.**

- Potential risk of electric shock or fire.
- Potential risk of damage to the air conditioner.

**Do not place any objects, especially containers with liquid.**



**Do not touch the pipe connected to the air conditioner.**



**This appliance should be installed according to the provided installation manual.**

**Install the shortest possible length of pipe.**

- If the length of pipe gets unnecessarily long, the life of air conditioner can be shorten and become inefficient.

**Install the power cable and communication cable of the indoor and outdoor unit at least 1m away from the electric appliance.**

**Install the indoor unit away from lighting apparatus using the ballast.**

- If you use the wireless remote control, reception error may occur due to the ballast of the lighting apparatus.

**For maximum safety, installers should always carefully read the following warnings.**

**Do not install the air conditioner in following places.**

- Place where there is mineral oil or arsenic acid.
- Resin parts flame and the accessories may drop or water may leak. The capacity of the heat exchanger may reduce or the air conditioner may be out of order.
- The place where corrosive gas such as sulfurous acid gas generates from the vent pipe or air outlet.
- The copper pipe or connection pipe may corrode and refrigerant may leak.
- The place where there is a machine that generates electromagnetic waves.  
The air conditioner may not operate normally due to control system.
- The place where there is a danger of existing combustible gas, carbon fiber or flammable dust.
- The place where thinner or gasoline is handled. Gas may leak and it may cause fire.

**If the air conditioner is installed in a small room, measures must be taken to prevent the refrigerant concentration in the room from exceeding the safety limit in the event of refrigerant leakage.**

**Consult a dealer regarding the appropriate measures to prevent the allowable concentration from being exceeded.**

- If the refrigerant leaks, and cause the concentration limit to be exceeded, hazards due to lack of oxygen in the room may result.

**Install the air conditioner away from direct exposure to sunlight, heating apparatus, and humid places.**

- Hang curtains on windows to boost cooling efficiency and to avoid the risk of electric shock.

**The air conditioner is composed of moving parts. Keep children away from the unit to avoid physical injury.**

 **Check for damage on delivery. If damaged, do not install the air conditioner and call the place of purchase immediately.**

**Insert the dust filter before operating the air conditioner.**

- If there is no dust filter inside the air conditioner, accumulated dust may shorten the life of the air conditioner and cause electricity waste.

**Keep indoor temperatures stable and not extremely cold, especially where there are children, elderly or disabled people.**

**Clean the dust filter every 2 weeks. Clean the filter more frequently if the air conditioner is operated in dusty areas.**

**The packaging material and used batteries of the remote controller (optional) must be disposed of in accordance with the national standards.**

**The refrigerant used in the air conditioner must be treated as chemical waste. Dispose the refrigerant following national standards.**

**Have a qualified service technician install the air conditioner and perform a trial operation.**

**Firmly connect the drain hose to the air conditioner for proper water drainage.**

**Install the outdoor unit where operating noise and vibration will not disturb your neighbor and in a well-ventilated area with no obstacle.**

- Potential risk of malfunction.
- Operating noise may disturb your neighbor.

**Make sure that children take precautions against access to the air conditioner and they do not play with the unit.**

**When using a wireless remote control, the distance should not be more than 7 meters from the air conditioner.**

**If the remote control is not used for a long period of time, remove the batteries to prevent leakage of electrolyte.**

**When cleaning the outdoor unit, touch the heat exchanger radiator fins with extreme care.**

- Wearing thick gloves can protect your hands.

**Make sure that the condensed water dripping from the drain hose runs out properly and safely.**

**Store the operation and installation manual in a safe location and remember to hand it over to the new owner if the air conditioner is sold or transferred.**

**All the materials used for the manufacture and packaging of the air conditioner are recyclable.**

**After completing the installation, always carry out a functional test and provide the instructions on how to operate the air conditioner to the user.**

**The appliance is not intended for use by young children or infirm persons without supervision: Young children should be supervised to ensure that they do not play with the appliance.**

**Clean the air conditioner after the inner fan stops operating.**

- Potential risk of injury or electric shock.

**Inspect the condition, electric connections, pipes and external case of the air conditioner regularly by a qualified service technician.**

**Do not open doors and windows in the room being cooled during operation unless necessary.**

**Do not block the air conditioner vents. If objects block the air flow, it may cause unit malfunction or poor performance.**

**Make sure there are no obstacles under the indoor unit.**

- Potential risk of fire or loss of property.

**Make sure that there are no obstacles or covers that block the air conditioner.**

**Allow sufficient space for air circulation.**



- Insufficient ventilation may result in poor performance.

# safety information

---

## CAUTION SIGNS

---

-  **Make sure the voltage and frequency of the electric system are compatible with the air conditioner.**
- If a power outage occurs while the air conditioner is working, turn off the power source immediately.
- Max current is measured according to IEC standard for safety and current is measured according to ISO standard for energy efficiency.
- The unit must be plugged into an independent circuit if applicable or connect the power cable to the auxiliary circuit breaker. An all pole disconnection from the power supply must be incorporated in the fixed wiring with a contact opening of >3mm.
- After connecting the power cable between the indoor/outdoor unit, attach the cover of component box securely and make sure it is not loose.
- For the power cable, use the grade of H07RN-F or H05RN-F materials.
- The unbalanced power must be maintained within 10% of supply rating among whole indoor units.
- If the power is unbalanced greatly, it may shorten the life of the condenser.  
If the unbalanced power is exceeded over 10% of supply rating, the indoor unit is protected, stopped and the error mode indicates.
- To protect the product from water and possible shock, you should keep the power cable and the connection cord of the indoor and outdoor units in the protection tube.
- Connect the power cable to the auxiliary circuit breaker.
- You must keep the cable in a protection tube.
- Keep distances of 50mm or more between power cable and communication cable.
- Maximum length of power cable is decided within 10% of power drop. If it exceeds, you must consider another power supplying method.
- The circuit breaker (MCCB, ELB) should be considered more capacity, if many indoor units are connected from one breaker.
- Use solderless ring terminal to connect the power cable to the power terminal block.
- Use an appropriate screwdriver for tightening the terminal screws.
- Over-tightening the terminal screws may break them.
-  **Ensure the off-on and protection switches are properly installed.**
- Do not use the air conditioner if damaged. If problems occur, immediately stop operation and disconnect the plug from the power supply.
- If the air conditioner will not be used for an extended period of time (for example, over several months), unplug the power from the wall.
-  **Call the place of purchase or a contact center if repairs are needed.**
- Potential risk of fire or electric shock if disassembly or repairs are attempted by a non-qualified service technician.
- If you smell burning plastic, hear strange sounds, or see smoke coming from the unit, unplug the air conditioner immediately and call a contact center.
- Potential risk of fire or electric shock.



# contents

<b>VIEWING YOUR AIR CONDITIONER</b>	<b>10</b>	<b>1 way &amp; slim 1 way cassette</b>
	<b>10</b>	<b>2 way cassette</b>
	<b>11</b>	<b>4 way &amp; mini 4 way cassette</b>
	<b>10</b>	
<b>USING YOUR AIR CONDITIONER</b>	<b>12</b>	<b>Tips on using your air conditioner</b>
	<b>12</b>	
<b>CLEANING AND MAINTAINING THE AIR CONDITIONER</b>	<b>13</b>	<b>Cleaning the exterior</b>
	<b>13</b>	<b>Cleaning the grille</b>
	<b>13</b>	1 way & slim 1 way cassette
	<b>15</b>	2 way cassette
	<b>16</b>	4 way & mini 4 way cassette
	<b>17</b>	<b>Cleaning the filter</b>
	<b>17</b>	1 way & slim 1 way cassette
	<b>18</b>	2 way cassette
	<b>19</b>	4 way & mini 4 way cassette
	<b>20</b>	<b>Maintaining your air conditioner</b>
	<b>20</b>	Periodical checks
	<b>21</b>	Internal protections via the unit control system
	<b>22</b>	<b>Troubleshooting</b>
<b>APPENDIX</b>	<b>23</b>	<b>Operation ranges</b>
	<b>22</b>	
<b>INSTALLING YOUR AIR CONDITIONER</b>	<b>24</b>	<b>Installation part</b>
	<b>24</b>	

This product has been determined to be in compliance with the Low Voltage Directive (2006/95/EC), and the Electromagnetic Compatibility Directive (2004/108/EEC) of the European Union.



### **Correct Disposal of This Product (Waste Electrical & Electronic Equipment)**

***(Applicable in the European Union and other European countries with separate collection systems)***

This marking shown on the product or its literature, indicates that it should not be disposed with other household wastes at the end of its working life. To prevent possible harm to the environment or human health from uncontrolled waste disposal, please separate this from other types of wastes and recycle it responsibly to promote the sustainable reuse of material resources.

Household users should contact either the retailer where they purchased this product, or their local government office, for details of where and how they can take this item for environmentally safe recycling.

Business users should contact their supplier and check the terms and conditions of the purchase contract. This product should not be mixed with other commercial wastes for disposal.

# viewing your air conditioner

Congratulations on the purchase of the air conditioner. We hope you enjoy the features of your air conditioner and stay cool or warm with optimal efficiency.

Please read the user manual to get started and to make the best use of the air conditioner.

## 1 WAY & SLIM 1 WAY CASSETTE

### Main parts

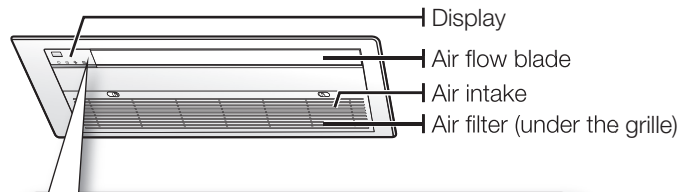

### Display

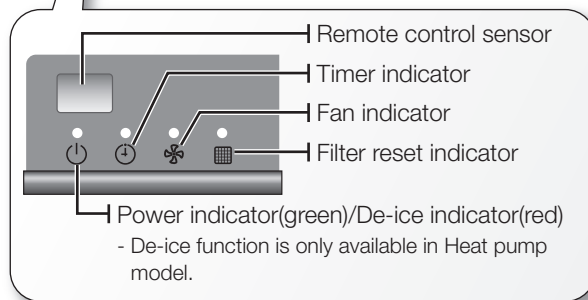

## 2 WAY CASSETTE

### Main parts

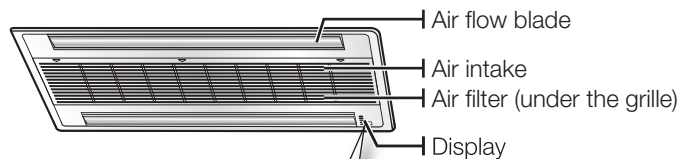

### Display

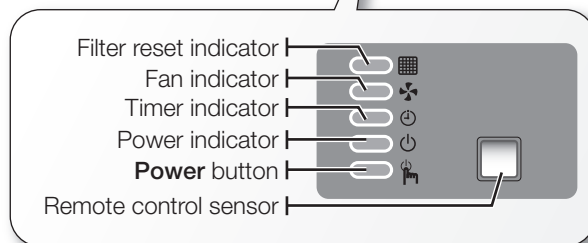

 Your air conditioner and display may look slightly different from the illustration shown above depending on your model.

# 4 WAY & MINI 4 WAY CASSETTE

## Main parts

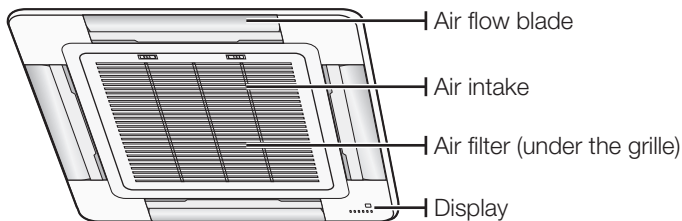

## Display

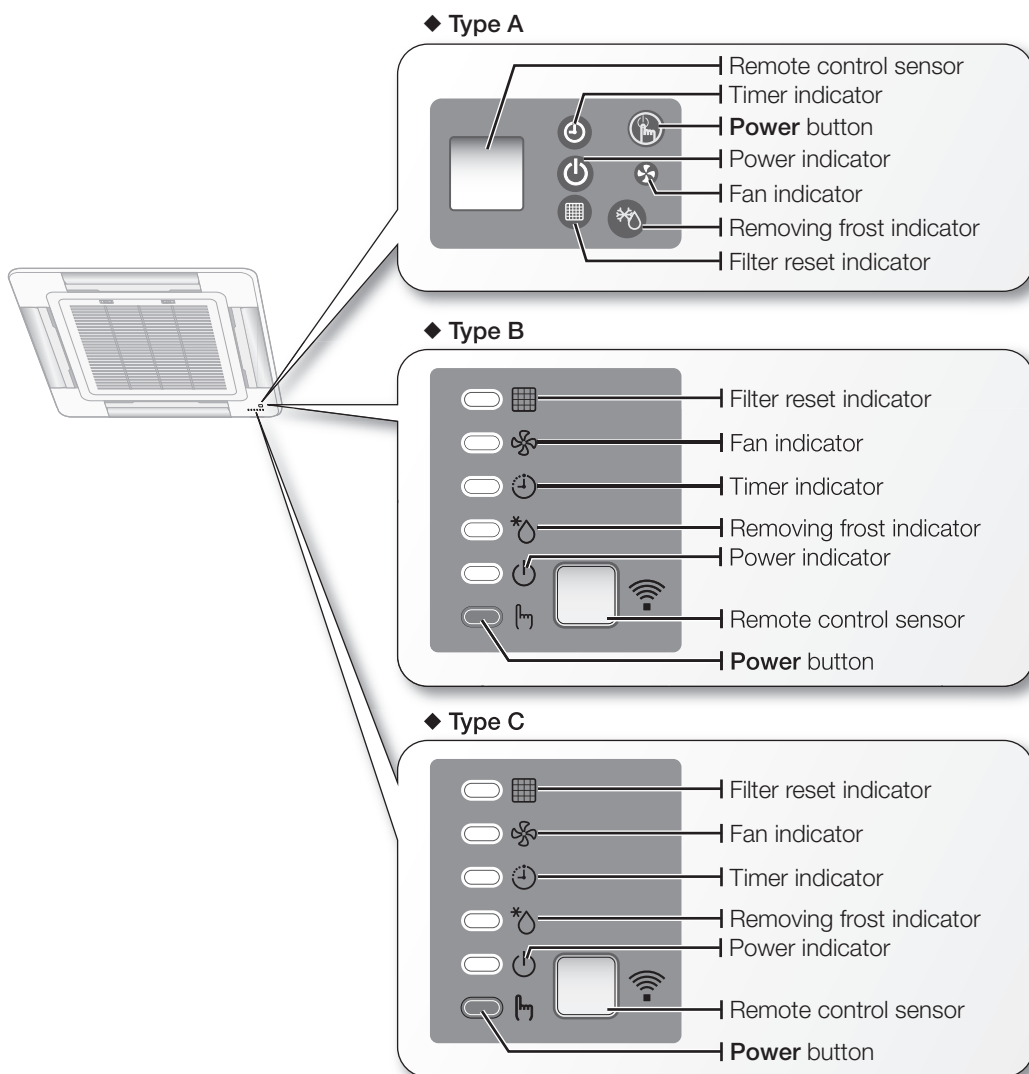

 Your air conditioner and display may look slightly different from the illustration shown above depending on your model.

# using your air conditioner

## TIPS ON USING AIR CONDITIONER

Here are some tips that you would follow when using your air conditioner.

TOPIC	RECOMMENDATION
Cooling	<ul style="list-style-type: none"><li>• If current outside temperatures are much higher than the selected indoor temperature, it may take time to bring the inner temperature to the desired coolness.</li><li>• Avoid drastically turning down the temperature. Energy is wasted and the room does not cool faster.</li></ul>
Heating	<ul style="list-style-type: none"><li>• Since the air conditioner heats the room by taking heat energy from outdoor air, the heating capacity may decrease when outdoor temperatures are extremely low. If you feel the air conditioner insufficiently heats, using an additional heating appliance in combination with the air conditioner is recommended.</li></ul>
Frost & De-ice	<ul style="list-style-type: none"><li>• When the air conditioner runs in Heat mode, due to temperature difference between the unit and the outside air, frost will form. If this happens:<ul style="list-style-type: none"><li>- The air conditioner stops heating.</li><li>- The air conditioner will operate automatically in De-ice mode for 10 minutes.</li><li>- The steam produced on the outdoor unit in De-ice mode is safe.</li></ul>No intervention is required; after about 10 minutes, the air conditioner operates again normally.  The unit will not operate when it starts to de-ice.</li></ul>
Fan	<ul style="list-style-type: none"><li>• Fan may not operate for about 3~5 minutes at the beginning to prevent any cold blasts while the air conditioner is warming up.</li></ul>
High indoor/outdoor temperatures	<ul style="list-style-type: none"><li>• If both indoor and outdoor temperatures are high and the air conditioner is running in Heat mode, the outdoor unit's fan and compressor may stop at times. This is normal; wait until the air conditioner turns on again.</li></ul>
Power failure	<ul style="list-style-type: none"><li>• If a power failure occurs during the operation of the air conditioner, the operating immediately stops and unit will be off. When power returns, the air conditioner will run automatically.</li></ul>
Protection mechanism	<ul style="list-style-type: none"><li>• If the air conditioner has just been turned on after operation stops or being plugged in, cool/warm air does not come out for 3 minutes to protect the compressor of the outdoor unit.</li></ul>

# cleaning and maintaining the air conditioner

For the best performance from your air conditioner, clean it periodically. When cleaning, make sure to unplug from the unit for user's safety.

## CLEANING THE EXTERIOR

When cleaning the exterior, make sure to unplug the power from the unit. No special tools are needed to clean it.

1. Wipe the surface of the unit with a slightly wet or dry cloth when needed. Wipe off dirt of odd-shaped area by using a soft brush.

**Example : 4 way cassette**

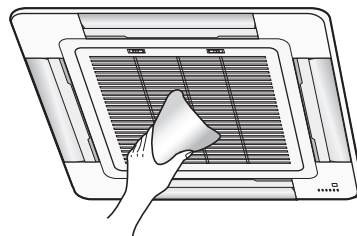

Do not use Benzene or Thinner.

They may damage the surface of the air conditioner and can create a risk of fire.

## CLEANING THE GRILLE

When cleaning the grille, make sure to unplug the power from the unit. No special tools are needed to clean it.

### 1 way & slim 1 way cassette

1. Open the front grille.

Push both of the tabs outwards to unlock the hook on the front grille.

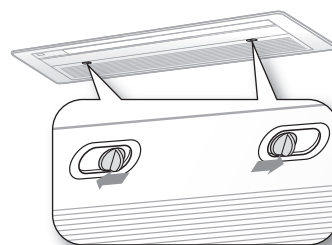

**OR,**

1. Push the **[PUSH]** tabs located in 3 places to unlock the groove on the front grille.

The grille automatically drops. Two safety clips are mounted to the inside front grille to prevent dropping downward.

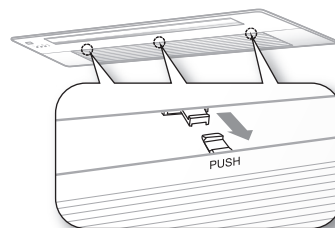

# cleaning and maintaining the air conditioner

---

## CLEANING THE GRILLE

---

2. Unhook the safety clips by holding the front grille.
3. Detach the front grille.  
Hold the front grille at a 45° angle, lift it up slightly and then pull the grille forward.

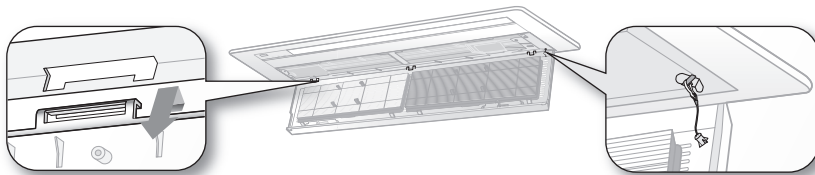

 **CAUTION** Hold the grille to prevent dropping outside from the opening of the front grille. If not, it may cause a potential risk of personal injury.

 Cleaning the grille is also available while being attached to the panel.

---

4. Pull out the Air filter.  
Grab the Air filter and lift it upwards while pushing slightly, and then pull the Air filter forward.
5. Clean the grille with a vacuum cleaner or soft brush. If dust is too heavy, then rinse it with running water and dry it in a ventilated area.

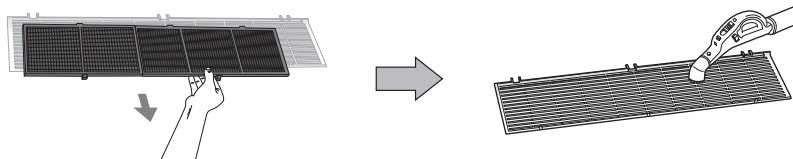

6. Insert the Air filter back in its original position.
  7. Reattach the front grille.  
Place the hook on the unit to the right place then push the front grille upward. Mount the safety clips to its original position.
- 

 The illustration shown above may differ from yours depending on your model.

## 2 way cassette

1. Open the front grille.

Push the [▼] tabs located in 3 places to unlock the groove on the front grille. The grille automatically drops. Two safety clips are mounted to the inside front grille to prevent dropping downward.

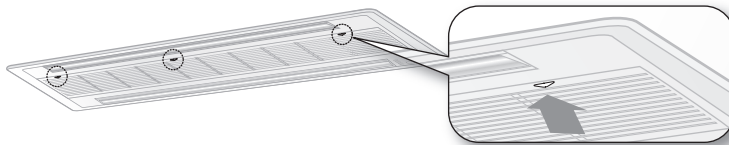

2. Unhook the safety clips by holding the front grille.

3. Detach the front grille.

Hold the front grille at a 45° angle, lift it up slightly and then pull the grille forward.

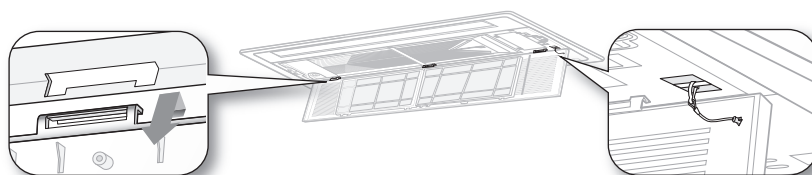

**CAUTION**  Hold the grille to prevent dropping outside from the opening of the front grille. If not, it may cause a potential risk of personal injury.

 Cleaning the grille is also available while being attached to the panel.

4. Pull out the Air filter.

Grab the Air filter and lift it upwards while pushing slightly, and then pull the Air filter forward.

5. Clean the grille with a vacuum cleaner or soft brush. If dust is too heavy, then rinse it with running water and dry it in a ventilated area.

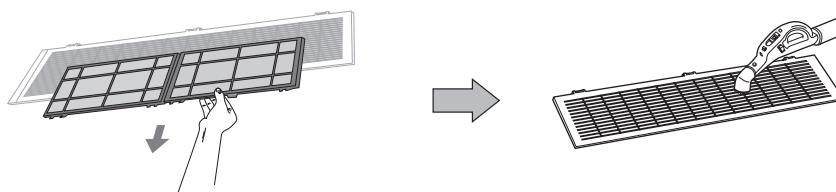

6. Insert the Air filter back in its original position.

7. Reattach the front grille.

Place the hook on the unit to the right place then push the front grille upward. Mount the safety clips to its original position.

# cleaning and maintaining the air conditioner

## CLEANING THE GRILLE

### 4 way & mini 4 way cassette

1. Open the front grille.

Push both of the tabs outwards to unlock the hook on the front grille. The grille automatically drops. Two safety clips are mounted to the inside front grille to prevent dropping downward.

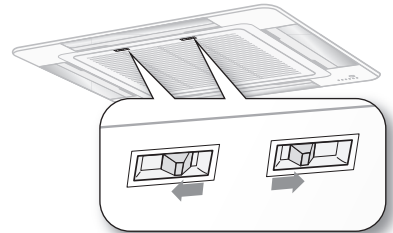

2. Unhook the safety clips by holding the front grille.

3. Detach the front grille.

Hold the front grille at a 45° angle, lift it up slightly and then pull the grille forward.

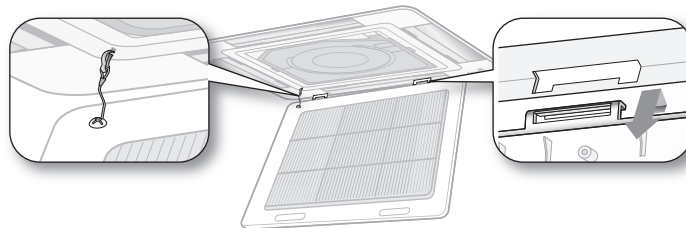

 **CAUTION** Hold the grille to prevent dropping outside from the opening of the front grille. If not, it may cause a potential risk of personal injury.

 Cleaning the grille is also available while being attached to the panel.

4. Pull out the Air filter.

Grab the Air filter and lift it upwards while pushing slightly, and then pull the Air filter forward.

5. Clean the grille with a vacuum cleaner or soft brush. If dust is too heavy, then rinse it with running water and dry it in a ventilated area.

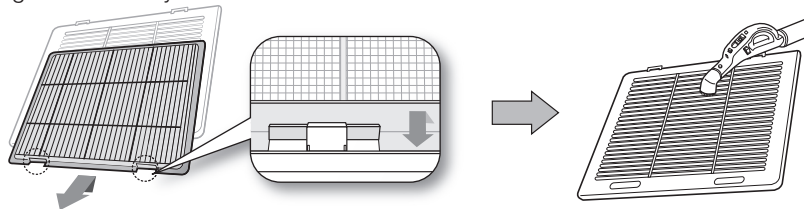

6. Insert the Air filter back in its original position.

You will hear a click sound when the Air filter is properly placed.

7. Reattach the front grille.

Place the hook on the unit to the right place then push the front grille upward. Mount the safety clips to its original position.

 The illustration shown above may differ from yours depending on your model.



## CLEANING THE FILTER

When cleaning the filter, make sure to unplug the power from the unit. Washable foam based Air filter captures large particles from the air. The filter is cleaned with a vacuum or by hand washing.

### 1 way & slim 1 way cassette

1. Open the front grille.

Push both of the tabs outwards to unlock the hook on the front grille.

OR,

1. Push the **[PUSH]** tabs located in 3 places to unlock the hook on the front grille.

The grille automatically drops. Two safety clips are mounted to the inside front grille to prevent dropping downward.

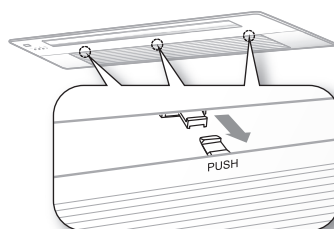
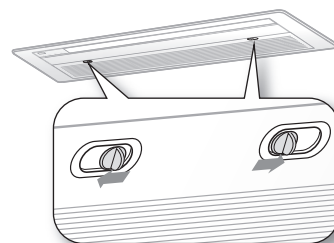

2. Pull out the Air filter.

Grab the Air filter and lift it upwards while pushing slightly, and then pull the Air filter forward.



When cleaning the filter you do not need to detach the grille at all times. If you want to detach the front grille, see step 2 and 3 on page 14 for instructions.

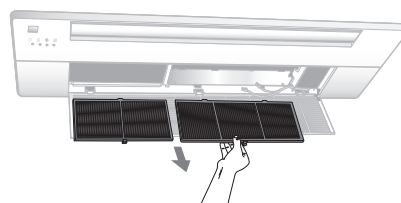

3. Clean the Air filter with a vacuum cleaner or soft brush. If dust is too heavy, then rinse it with running water and dry it in a ventilated area.

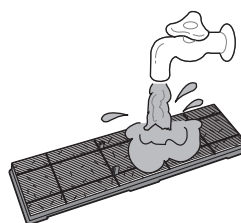
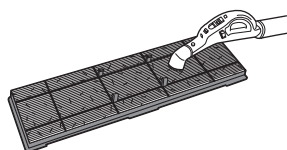

- For best conditions, repeat every two weeks.
- If the Air filter dries in a confined (or humid) area, odors may generate. If it occurs, re-clean and dry it in a well-ventilated area.

4. Insert the Air filter back in its original position.

You will hear a click sound when the Air filter is properly placed.

5. Close the front grille by pushing it upward.



- The illustration shown above may differ from yours depending on your model.
- After cleaning the filter, press the **Filter Reset** button on the remote control for 2 seconds to reset the filter schedule. Filter sign indicator will be on for cleaning time.

# cleaning and maintaining the air conditioner

---

## CLEANING THE FILTER

---

When cleaning the filter, make sure to unplug the power from the unit. Washable foam based Air filter captures large particles from the air. The filter is cleaned with a vacuum or by hand washing.

### 2 way cassette

1. Open the front grille.

Push the [▼] tabs located in 3 places to unlock the hook on the front grille.

The grille automatically drops. Two safety clips are mounted to the inside front grille to prevent dropping downward.

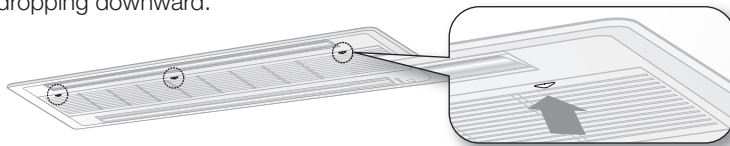

2. Pull out the Air filter.

Grab the Air filter and lift it upwards while pushing slightly, and then pull the Air filter forward.

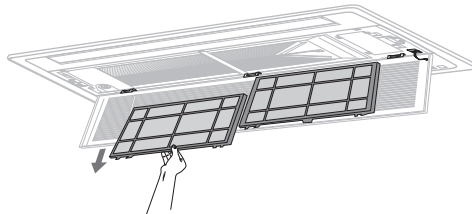

-  When cleaning the filter you do not need to detach the grille at all times. If you want to detach the front grille, see step 2 and 3 on page 15 for instructions.

3. Clean the Air filter with a vacuum cleaner or soft brush. If dust is too heavy, then rinse it with running water and dry it in a ventilated area.

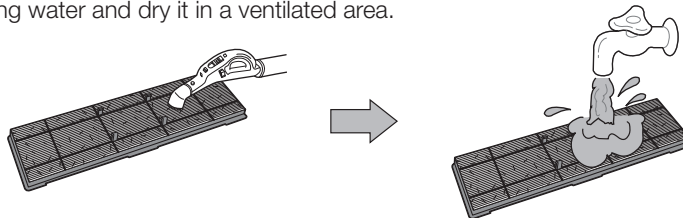

-  • For best conditions, repeat every two weeks.  
• If the Air filter dries in a confined (or humid) area, odors may generate. If it occurs, re-clean and dry it in a well-ventilated area.

4. Insert the Air filter back in its original position.

You will hear a click sound when the Air filter is properly placed.

5. Close the front grille by pushing it upward.

-  After cleaning the filter, press the **Filter Reset** button on the remote control for 2 seconds to reset the filter schedule. Filter sign indicator will be on for cleaning time.

## 4 way & mini 4 way cassette

1. Push both of the tabs outwards to unlock the hook on the front grille.

The grille automatically drops. Two safety clips are mounted to the inside front grille to prevent dropping downward.

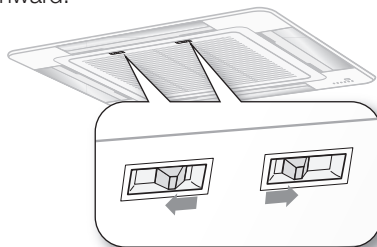

2. Pull out the Air filter.

Grab the Air filter and lift it upwards while pushing slightly, and then pull the Air filter forward.

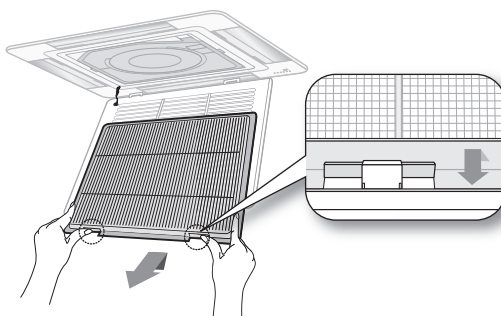

-  When cleaning the filter you do not need to detach the grille at all times. If you want to detach the front grille, see step 2 and 3 on page 16 for instructions.

3. Clean the Air filter with a vacuum cleaner or soft brush. If dust is too heavy, then rinse it with running water and dry it in a ventilated area.

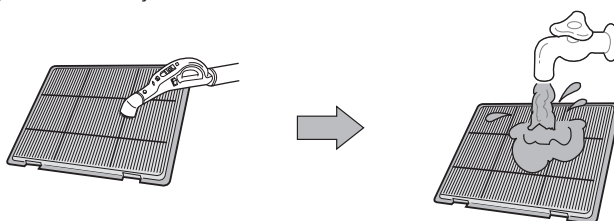

-  • For best conditions, repeat every two weeks.  
• If the Air filter dries in a confined (or humid) area, odors may generate. If it occurs, re-clean and dry it in a well-ventilated area.

4. Insert the Air filter back in its original position.

You will hear a click sound when the Air filter is properly placed.

5. Close the front grille by pushing it upward.

-  • The illustration shown above may differ from yours depending on your model.  
• After cleaning the filter, press the **Filter Reset** button on the remote control for 2 seconds to reset the filter schedule. Filter sign indicator will be on for cleaning time.

# cleaning and maintaining the air conditioner

## MAINTAINING YOUR AIR CONDITIONER

If the air conditioner will not be used for an extended period of time, dry the air conditioner to maintain it in best condition.

1. Dry the air conditioner thoroughly by operating in Fan mode for 3 to 4 hours and disconnect the power plug. There may be internal damage if moisture is left in components.
2. Before using the air conditioner again, dry the inner components of the air conditioner again by running in Fan mode for 3 to 4 hours. This helps remove odors which may have generated from dampness.

### Periodical checks

Refer to the following chart to maintain the air conditioner properly.

Type	Description	Monthly	Every 4 months	Once a year
Indoor unit	Clean the air filter (1)	●		
	Clean the condensate drain pan (2)			●
	Thoroughly clean the heat exchanger (2)			●
	Clean the condensate drain pipe (2)		●	
	Replace the remote control batteries (1)			●
Outdoor unit	Clean the heat exchanger on the outside of the unit (2)		●	
	Clean the heat exchanger on the inside of the unit (2)			●
	Clean the electric components with jets of air (2)			●
	Verify that all the electric components are firmly tightened (2)			●
	Clean the fan (2)			●
	Verify that all the fan assembly is firmly tightened (2)			●
	Clean the condensate drain pan (2)			●

 The checks and maintenance operations described are essential to guarantee the efficiency of the air conditioner. The frequency of these operations varies according to the characteristics of the area, the amount of dust, etc.

(1) The described operations should be performed more frequently if the area of installation is very dusty.

(2) These operations must always be performed by qualified personnel. For more detailed information, see the Installation Manual.

## Internal protections via the unit control system

This internal protection operates if an internal fault occurs in the air conditioner.

Type	Description
Against cold air	The internal fan will be off to against cold air when the heat pump is heating.
De-ice cycle	The internal fan will be off to against cold air when the heat pump is heating.
Anti-protection of internal battery	The compressor will be off to protect internal battery when the air conditioner operates in Cool mode.
Protect compressor	The air conditioner does not start operating immediately to protect the compressor of the outdoor unit after it has been started.



If the heat pump is operating in Heat mode, De-ice cycle is actuated to remove frost from an outdoor unit that may have deposited at low temperatures.

The internal fan is switched off automatically and restarted only after the de-ice cycle is completed.

# appendix

## TROUBLESHOOTING

Refer to the following chart if the air conditioner operates abnormally. This may save time and unnecessary expenses.

PROBLEM	SOLUTION
The air conditioner does not operate immediately after it has been restarted.	<ul style="list-style-type: none"> <li>Because of the protective mechanism, the appliance does not start operating immediately to keep the unit from overloading. The air conditioner will start in 3 minutes.</li> </ul>
The air conditioner does not work at all.	<ul style="list-style-type: none"> <li>Check that the power plug is properly connected. Insert the power plug into the wall socket correctly.</li> <li>Check if the circuit breaker is switched off.</li> <li>Check if there is a power failure.</li> <li>Check your fuse. Make sure it is not blown out.</li> </ul>
The temperature does not change.	<ul style="list-style-type: none"> <li>Check if you selected Fan mode. Press the <b>Mode</b> button on the remote control to select another mode.</li> </ul>
The cool (warm) air does not come out of the air conditioner.	<ul style="list-style-type: none"> <li>Check if the set temperature is higher (lower) than the current temperature. Press the <b>Temperature</b> button on the remote control to change the set temperature. Press the <b>Temperature</b> button to decrease or increase the temperature.</li> <li>Check if the air filter is blocked by dirt. Clean the air filter every two weeks.</li> <li>Check if the air conditioner has just been turned on. If so, wait 3 minutes. Cool air does not come out to protect the compressor of the outdoor unit.</li> <li>Check if the air conditioner is installed in a place with a direct exposure to sunlight. Hang curtains on windows to boost cooling efficiency.</li> <li>Check if the cover or any obstacle is not near the outdoor unit.</li> <li>Check if the refrigerant pipe is too long.</li> <li>Check if the air conditioner is only available in Cool mode.</li> <li>Check if the remote control is only available for cooling model.</li> </ul>
The fan speed does not change.	<ul style="list-style-type: none"> <li>Check if you selected Auto or Dry mode. The air conditioner automatically adjusts the fan speed to Auto in Auto/Dry mode.</li> </ul>
Timer function does not set.	<ul style="list-style-type: none"> <li>Check if you press the <b>Power</b> button on the remote control after you have set the time.</li> </ul>
Odors permeate in the room during operation.	<ul style="list-style-type: none"> <li>Check if the appliance is running in a smoky area or if there is a smell entering from outside. Operate the air conditioner in Fan mode or open the windows to air out the room.</li> </ul>
The air conditioner makes a bubbling sound.	<ul style="list-style-type: none"> <li>A bubbling sound may be heard when the refrigerant is circulating through the compressor. Let the air conditioner operate in a selected mode.</li> <li>When you press the <b>Power</b> button on the remote control, noise may be heard from the drain pump inside the air conditioner.</li> </ul>
Water is dripping from the air flow blades.	<ul style="list-style-type: none"> <li>Check if the air conditioner has been cooling for an extended period of time with the air flow blades pointed downwards. Condensation may generate due to the difference in temperature.</li> </ul>
Remote control is not working.	<ul style="list-style-type: none"> <li>Check if your batteries are depleted.</li> <li>Make sure batteries are correctly installed.</li> <li>Make sure nothing is blocking your remote control sensor.</li> <li>Check that there are strong lighting apparatus near the air conditioner. Strong light which comes from fluorescent bulbs or neon signs may interrupt the electric waves.</li> </ul>
The air conditioner does not turn on or off with the wired remote control.	<ul style="list-style-type: none"> <li>Check if you set the wired remote control for group control.</li> </ul>
The wired remote control does not operate.	<ul style="list-style-type: none"> <li>Check if TEST indicator is displayed on the wired remote control. If so, turn off the unit and switch off the circuit breaker. Call your nearest contact center.</li> </ul>
The indicators of the digital display flashes.	<ul style="list-style-type: none"> <li>Press the <b>Power</b> button on the remote control to turn the unit off and switch the circuit breaker off. Then, switch it on again.</li> </ul>

## OPERATION RANGES

The table below indicates the temperature and humidity ranges the air conditioner can be operated within. Refer to the table for efficient use.

MODE	OUTDOOR TEMPERATURE	INDOOR TEMPERATURE	INDOOR HUMIDITY	REMARKS
COOLING	-5°C/23°F to 43°C/109°F	18°C/64°F to 32°C/90°F	80% or less	DVM, DVM PLUS II/III, BAC Inverter BAC, Free Joint Multi BAC Inverter(UH026/035EAV1) BAC Inverter(UH052/060/070EAV1)
	-5°C/23°F to 43°C/109°F	21°C/70°F to 32°C/90°F		
	-10°C/14°F to 43°C/109°F	18°C/64°F to 32°C/90°F		
	-15°C/5°F to 43°C/109°F	18°C/64°F to 32°C/90°F		
HEATING	-20°C/-4°F to 24°C/75°F	27°C/81°F or less	-	DVM PLUS II/III, BAC Inverter(UH052/060/070EAV1) BAC Free Joint Multi, DVM, BAC Inverter(UH026/035EAV1) BAC Inverter
	-5°C/23°F to 24°C/75°F	15°C/59°F to 27°C/81°F		
	-15°C/5°F to 24°C/75°F	27°C/81°F or less		
	-10°C/14°F to 24°C/75°F	27°C/81°F or less		
DRYING	-5°C/23°F to 43°C/109°F	18°C/64°F to 32°C/90°F	-	DVM, DVM PLUS II/III, Free Joint Multi, BAC Inverter BAC BAC Inverter(UH026/035EAV1) BAC Inverter(UH052/060/070EAV1)
	-5°C/23°F to 43°C/109°F	21°C/70°F to 32°C/90°F		
	-10°C/14°F to 43°C/109°F	18°C/64°F to 32°C/90°F		
	-15°C/5°F to 43°C/109°F	18°C/64°F to 32°C/90°F		

 The standardized temperature for heating is 7°C/45°F. If the outdoor temperature drops to 0°C/32°F or below, the heating capacity can be reduced depending on the temperature condition.  
If the cooling operation is used at over 32°C/90°F (indoor temperature), it does not cool at its full capacity.

Model \ Type	1 Way cassette	Slim 1 Way cassette	2 Way cassette	4 Way cassette	mini 4 Way cassette
DVM	AVMKH(C)**	-	AVMGH(C)**	AVMCH(C)** AVMC4**	-
DVM PLUS II/III	AVXC1**	AVXCS**	AVXC2**	AVXC4**	AVXCM**
BAC	KH(C)**EAM	-	GH(C)**EAM	CH(C)**EAM* CH(C)**EZM*	-
BAC Inverter	KH***EAV	SH***EAV*	-	CH***EAV* CH***EAS	TH***EAV*
Free Joint Multi	MH***FK**	MH***FS**	-	-	MH***FM*

# Installation Part

## (DVM PLUS II/DVM PLUS III)

### Indoor Unit Installation

It is recommended to install the Y-joint before installing the indoor unit.

- Place the pattern sheet on the ceiling at the spot where you want to install the indoor unit.

**Note** Since the diagram is made of paper, it may shrink or stretch slightly due to temperature or humidity. For this reason, before drilling the holes maintain the correct dimensions between the markings.

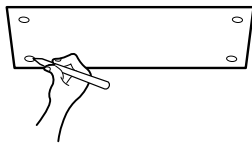

- Insert bolt anchors, use existing ceiling supports or construct a suitable support as shown in figure.

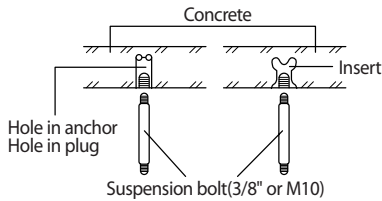

- Install the suspension bolts depending on the ceiling type.

- CAUTION**
- ◆ Ensure that the ceiling is strong enough to support the weight of the indoor unit. Before hanging the unit, test the strength of each attached suspension bolt.
  - ◆ If the length of suspension bolt is more than 1.5m, it is required to prevent vibration.
  - ◆ If this is not possible, create an opening on the false ceiling in order to be able to use it to perform the required operations on the indoor unit.

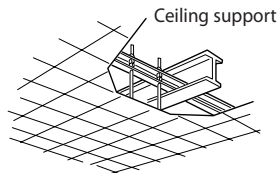

- Screw eight nuts to the suspension bolts making space for hanging the indoor unit.

**CAUTION** You must install the suspension bolts more than four when installing the indoor unit.

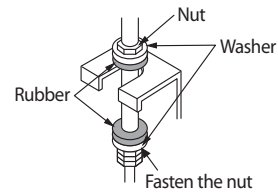

- Check the level of the indoor unit by using a leveler.

- ◆ A tilt of the indoor unit may cause malfunction of a built-in float switch and water leaks.

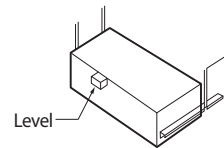

- Adjust the height of the indoor unit by using the gauge of dimensions.

- ◆ You should adjust the gauge of dimensions and the pattern sheet to fit the cutting dimensions of ceiling.
- ◆ Make sure that the indoor unit is installed at a level if the indoor unit slants too much, there can be water leaks.

#### AVXC1\*\*

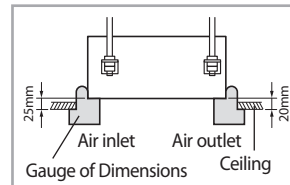

#### AVXCS\*\*

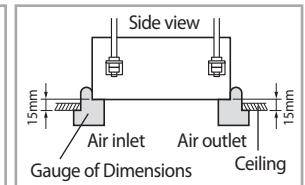

#### AVXC2\*\*

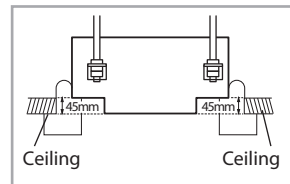

#### AVXC4\*\*

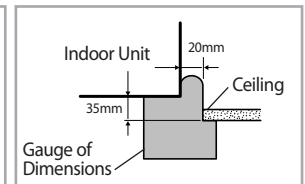

#### AVXCM\*\*

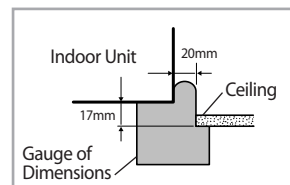

- Tighten the upper part nuts.

- Remove the gauge of dimensions after installing the indoor unit.



## Performing Leak Test & Insulation

### Leak test

#### LEAK TEST WITH NITROGEN(before opening valves)

In order to detect basic refrigerant leaks, before recreating the vacuum and recirculating the R410A, it's responsible of installer to pressurize the whole system with nitrogen(using a pressure regulator) at a pressure above 4.1MPa(gauge).

#### LEAK TEST WITH R410A(after opening valves)

Before opening valves, discharge all the nitrogen into the system and create vacuum. After opening valves check leaks using a leak detector for refrigerant R410A.

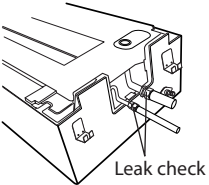

\* The designs and shape are subject to change according to the model.

#### CAUTION

**Discharge all the nitrogen to create a vacuum and charge the system.**

### Insulation

Once you have checked that there are no leaks in the system, you can insulate the piping and hose.

- To avoid condensation problems, place **T13.0 or thicker Acrylonitrile Butadien Rubber** separately around each refrigerant pipe.

**Note** Always make the seam of pipes face upwards.

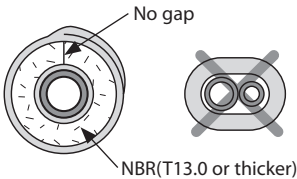

- Wind insulating tape around the pipes and drain hose avoiding to compress the insulation too much.

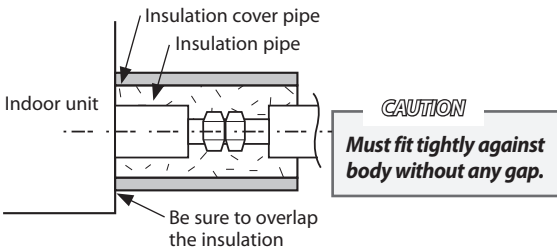

- Finish wrapping insulating tape around the rest of the pipes leading to the outdoor unit.
- The pipes and electrical cables connecting the indoor unit with the outdoor unit must be fixed to the wall with suitable ducts.

#### CAUTION

**All refrigerant connection must be accessible, in order to permit either unit maintenance or removing it completely.**

- Select the insulation of the refrigerant pipe.

- ◆ Insulate the gas side and liquid side pipe referring to the thickness according to the pipe size.
- ◆ The thickness according to the pipe size is a standard of the indoor temperature of 27°C and humidity of 80%. If installing in an unfavorable conditions, use thicker one.
- ◆ Insulator's heat-resistance temperature should be more than 120°C.

Pipe size (mm)	Minimum thickness of insulation (mm)		Remarks
	PE foam	EPDM foam	
Ø6.35~Ø15.88	13	10	If you install the pipe underground, at the seaside, a spa or on the lake, use 1 grade thicker one according to the pipe size.
-	25	19	

#### CAUTION

- ◆ **Install the insulation not to get wider and use the adhesives on the connection part of it to prevent moisture from entering.**
- ◆ **Wind the refrigerant pipe with insulation tape if it is exposed to outside sunlight.**
- ◆ **Install the refrigerant pipe respecting that the insulation does not get thinner on the bent part or hanger of pipe.**
- ◆ **Add the additional insulation if the insulation plate gets thinner.**

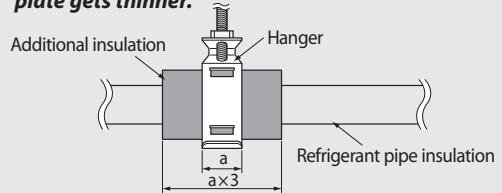

## Drain pipe and Drain Hose Installation

- Install the drain pipe as shortly as possible.
  - ◆ Give a slightly slant to the drainpipe for proper drainage of condensate water.
  - ◆ There must be no gap on the connected part so that the drainpipe is not separated from the flexible hose.
- Insulate the drainpipe, and then fix it as indicated.
  - ◆ Whole drainpipe should be insulated by 5t(or more) insulation to prevent water condensation.

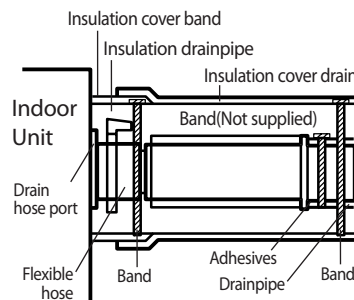

### \* Flexible hose Installation

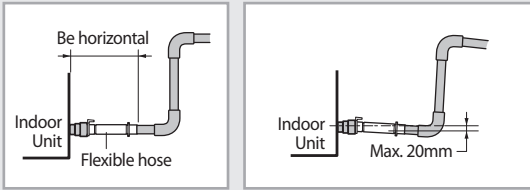

◆ Install horizontally

◆ Max. allowable axis gap

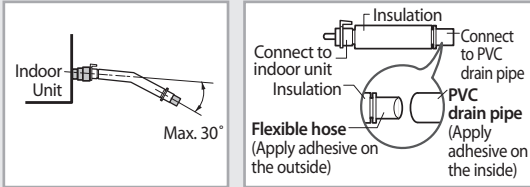

◆ Max. allowable bending angle

◆ Handle with using adhesive not to block the inside of flexible hose

### Drainpipe Connection

1. The drain pipe should be installed within 100mm from the flexible hose, lift up from 100mm to 550mm and lift down 20mm or more.
2. Install horizontal drainpipe with a slope of 1/100 or more and fix it by hanger space of 1~1.5m.
3. Install the air vent in the horizontal drainpipe to prevent water flow back to the indoor unit.  
*Note* You may not need to install it if there were proper slope in the horizontal drainpipe.

4. The flexible hose should not be installed upward position, it may cause water flow back to the indoor unit.
5. Install U-trap at the end of the drainpipe to prevent a nasty smell to reach the indoor unit.

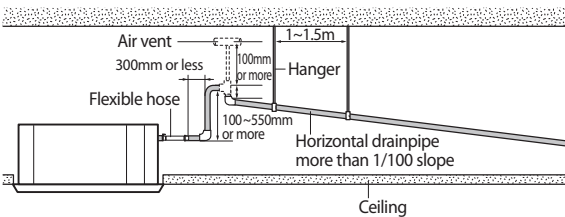

### Centralized Drainage

1. Install main air vent at the front of the farthest indoor unit from the main drain when installed indoor units are more than 3.
2. You may need to install individual air vent to prevent water flow back at the top of each indoor unit drainpipe.

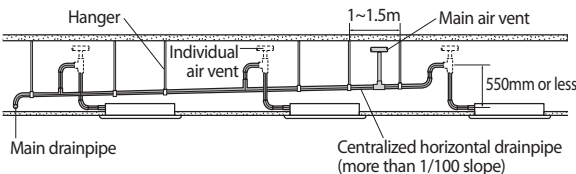

## Wiring Work

### Power and communication cable connection

1. Before wiring work, you must turn off all power source.
2. Indoor unit power should be supplied through the breaker(MCCB, ELB) separated by the outdoor power.
3. The power cable should be used only copper wires.
4. Connect the power cable{1(L), 2(N)} among the units within maximum length and communication cable(F1, F2) each.
5. Connect V1, V2(for DC12V) and F3, F4(for communication) when installing the wired remote Control.

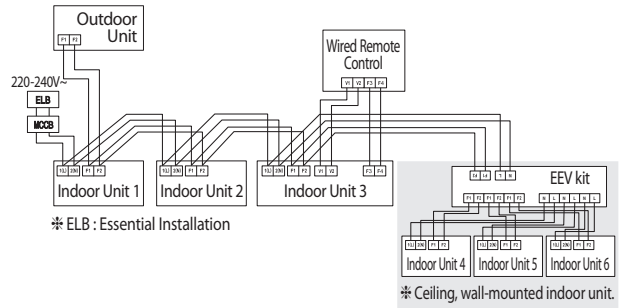

### Selecting compressed ring terminal

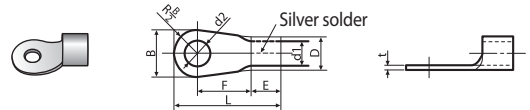

Nominal dimensions for cable (mm <sup>2</sup> )	Nominal dimensions for screw (mm)	B		D		d1		E F L			d2		t
		Standard dimension (mm)	Allowance (mm)	Standard dimension (mm)	Allowance (mm)	Standard dimension (mm)	Allowance (mm)	Min.	Min.	Max.	Standard dimension (mm)	Allowance (mm)	
1.5	4	6.6	±0.2	3.4	+0.3 -0.2	1.7	±0.2	4.1	6	16	4.3	+0.2 0	0.7
	4	8											
2.5	4	6.6	±0.2	4.2	+0.3 -0.2	2.3	±0.2	6	6	17.5	4.3	+0.2 0	0.8
	4	8.5											
4	4	9.5	±0.2	5.6	+0.3 -0.2	3.4	±0.2	6	5	20	4.3	+0.2 0	0.9

### Specification of electronic wire

Power supply	MCCB	ELB	Power cable	Earth cable	Communication cable
Max : 242V Min : 198V	X A	X A, 30mA 0.1 sec	2.5mm <sup>2</sup>	2.5mm <sup>2</sup>	0.75~1.5mm <sup>2</sup>

- ◆ Decide the capacity of ELB and MCCB by below formula.

$$\text{The capacity of ELB, MCCB } X [A] = 1.25 \times 1.1 \times \sum A_i$$

- \* X : The capacity of ELB, MCCB
- \*  $\sum A_i$  : Sum of Rating currents of each indoor unit.
- \* Refer to each installation manual about the rating current of indoor unit.

- ◆ Decide the power cable specification and maximum length within 10% power drop among indoor units.

$$\sum_{k=1}^n \left( \frac{\text{Coef} \times 35.6 \times L_k \times i_k}{1000 \times A_k} \right) < 10\% \text{ of input voltage [V]}$$

- \* Coef: 1.55
- \*  $L_k$ : Distance among each indoor unit[m],
- \*  $A_k$ : Power cable specification[mm<sup>2</sup>],  $i_k$ : Running current of each unit[A]

## Indoor Unit Setting

1. Before installing the indoor unit, assign an address to the indoor unit according to the air conditioning system plan.
2. The address of the indoor unit is assigned by adjusting MAIN(SW01, SW02) and RMC(SW03, SW04) rotary switches.

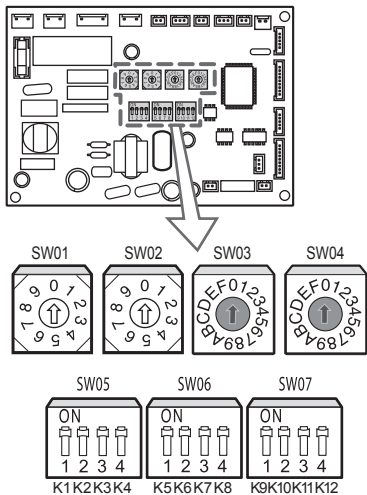

\* The designs and shape are subject to change according to the model.

### Setting MAIN Address

- ◆ The MAIN address is for communication between the indoor unit and the outdoor unit. Therefore, you must set it to operate the air conditioner properly.
- ◆ You can set the MAIN address from '00' to '99' by mixing SW01 and SW02. The MAIN address from '00' to '99' should differ from each other.
- ◆ Check the indoor unit address on the plan that you are to install and set the address according to the plan.

**Note** You may not need to set MAIN address if you selected Auto Address Setting from the outdoor unit: see details on the outdoor unit installation manual.

**For Example** When MAIN address is set as "12".

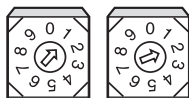

### Setting RMC Address

- ◆ You must set the SW03, SW04 and K2 switch when using the centralized controller.

**For Example** When RMC address is set as "12".

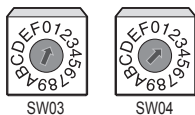

## Additional Functions

SW05

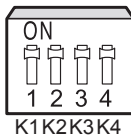

No.	Function	ON	OFF		
SW05	K1	Wired remote control	-	-	
	K2	Centralized controller	Not use	Use	
	K3	RPM up	1way/Slim 1way/2way/mini 4way	N/A	N/A
			4way	Normal	Up
K4	Option drain pump	N/A	N/A		

\* N/A : Not Available

SW06

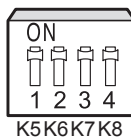

No.	Function	ON	OFF	
SW06	K5 Heating thermo-off	1way/Slim 1way/2way	+2°C	+5°C
		mini 4way/4way	+5°C	+2°C
K6	Filter signal display	1000 hours	2000 hours	
K7	Hot water coil	N/A	N/A	
K8	Electrical heater	N/A	N/A	

\* N/A : Not Available

SW07

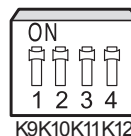

No.	Function	ON	OFF	
SW07	K9	Min. EEV step at heating	Fix 80 step	0 or 80 step
	K10	Priority of indoor unit display on wired remote controller	Slave	Master
	K11	External control	Not Use	Use
	K12	Spare	-	-

\* N/A : Not Available



## QUESTIONS OR COMMENTS?

COUNTRY	CALL	OR VISIT US ONLINE AT	COUNTRY	CALL	OR VISIT US ONLINE AT
BELGIUM	02 201 2418	<a href="http://www.samsung.com/be">www.samsung.com/be</a>	CANADA	1-800-SAMSUNG (726-7864)	<a href="http://www.samsung.com/ca">www.samsung.com/ca</a>
CZECH REPUBLIC	800-SAMSUNG (800-726786) Distributor pro Českou republiku: Samsung Zrt., česká organizační složka, Oasis Florenc, Sokolovská394/17, 180 00, Praha 8	<a href="http://www.samsung.com/cz">www.samsung.com/cz</a>	MEXICO	01-800-SAMSUNG (726-7864)	<a href="http://www.samsung.com/mx">www.samsung.com/mx</a>
DENMARK	8-SAMSUNG (7267864)	<a href="http://www.samsung.com/dk">www.samsung.com/dk</a>	U.S.A	1-800-SAMSUNG (726-7864)	<a href="http://www.samsung.com/us">www.samsung.com/us</a>
FINLAND	30-6227 515	<a href="http://www.samsung.com/fi">www.samsung.com/fi</a>	ARGENTINE	0800-333-3733	<a href="http://www.samsung.com/ar">www.samsung.com/ar</a>
FRANCE	3260 SAMSUNG (7267864, €0,15/Min) 0825 08 65 65 (€0,15/Min)	<a href="http://www.samsung.com/fr">www.samsung.com/fr</a>	BRAZIL	0800-124-421 4004-0000	<a href="http://www.samsung.com/br">www.samsung.com/br</a>
GERMANY	01805-SAMSUNG (7267864, €0,14/Min)	<a href="http://www.samsung.de">www.samsung.de</a>	CHILE	800-SAMSUNG (726-7864)	<a href="http://www.samsung.com/cl">www.samsung.com/cl</a>
HUNGARY	06-80-SAMSUNG (7267864)	<a href="http://www.samsung.com/hu">www.samsung.com/hu</a>	NICARAGUA	00-1800-5077267	<a href="http://www.samsung.com/latin">www.samsung.com/latin</a>
ITALIA	800-SAMSUNG (7267864)	<a href="http://www.samsung.com/it">www.samsung.com/it</a>	HONDURAS	800-7919267	<a href="http://www.samsung.com/latin">www.samsung.com/latin</a>
LUXEMBURG	02 261 03 710	<a href="http://www.samsung.com/lu">www.samsung.com/lu</a>	COSTA RICA	0-800-507-7267	<a href="http://www.samsung.com/latin">www.samsung.com/latin</a>
NETHERLANDS	0900-SAMSUNG (7267864, €0,10/Min)	<a href="http://www.samsung.com/nl">www.samsung.com/nl</a>	ECUADOR	1-800-10-7267	<a href="http://www.samsung.com/latin">www.samsung.com/latin</a>
NORWAY	3-SAMSUNG (7267864)	<a href="http://www.samsung.com/no">www.samsung.com/no</a>	EL SALVADOR	800-6225	<a href="http://www.samsung.com/latin">www.samsung.com/latin</a>
POLAND	0-801-1SAMSUNG (172678) 022-607-93-33	<a href="http://www.samsung.com/pl">www.samsung.com/pl</a>	GUATEMALA	1-800-299-0013	<a href="http://www.samsung.com/latin">www.samsung.com/latin</a>
PORTUGAL	808 20-SAMSUNG (7267864)	<a href="http://www.samsung.com/pt">www.samsung.com/pt</a>	JAMAICA	1-800-234-7267	<a href="http://www.samsung.com/latin">www.samsung.com/latin</a>
SLOVAKIA	0800-SAMSUNG (7267864)	<a href="http://www.samsung.com/sk">www.samsung.com/sk</a>	PANAMA	800-7267	<a href="http://www.samsung.com/latin">www.samsung.com/latin</a>
SPAIN	902-1-SAMSUNG (902 172 678)	<a href="http://www.samsung.com/es">www.samsung.com/es</a>	PUERTO RICO	1-800-682-3180	<a href="http://www.samsung.com/latin">www.samsung.com/latin</a>
SWEDEN	075-SAMSUNG (726 78 64)	<a href="http://www.samsung.com/se">www.samsung.com/se</a>	REP. DOMINICA	1-800-751-2676	<a href="http://www.samsung.com/latin">www.samsung.com/latin</a>
U.K	0845 SAMSUNG (7267864)	<a href="http://www.samsung.com/uk">www.samsung.com/uk</a>	TRINIDAD & TOBAGO	1-800-SAMSUNG (726-7864)	<a href="http://www.samsung.com/latin">www.samsung.com/latin</a>
EIRE	0818 717 100	<a href="http://www.samsung.com/ie">www.samsung.com/ie</a>	VENEZUELA	0-800-100-5303	<a href="http://www.samsung.com/latin">www.samsung.com/latin</a>
AUSTRIA	0810-SAMSUNG (7267864, €0,07/min)	<a href="http://www.samsung.com/at">www.samsung.com/at</a>	COLOMBIA	01-8000112112	<a href="http://www.samsung.com/co">www.samsung.com.co</a>
SWITZERLAND	0848-SAMSUNG (7267864, CHF 0,08/min)	<a href="http://www.samsung.com/ch">www.samsung.com/ch</a>	AUSTRALIA	1300 362 603	<a href="http://www.samsung.com/au">www.samsung.com/au</a>
RUSSIA	8-800-555-55-55	<a href="http://www.samsung.ru">www.samsung.ru</a>	INDIA	3030 8282 1800 110011 1-800-3000-8282	<a href="http://www.samsung.com/in">www.samsung.com/in</a>
KAZAKHSTAN	8-10-800-500-55-500	<a href="http://www.samsung.com/kz_ru">www.samsung.com/kz_ru</a>			
UZBEKISTAN	8-10-800-500-55-500	<a href="http://www.samsung.com/kz_ru">www.samsung.com/kz_ru</a>			
KYRGYZSTAN	00-800-500-55-500				
TADJIKISTAN	8-10-800-500-55-500				
UKRAINE	8-800-502-0000	<a href="http://www.samsung.ua">www.samsung.ua</a>			
LITHUANIA	8-800-7777	<a href="http://www.samsung.lt">www.samsung.lt</a>			
LATVIA	8000-7267	<a href="http://www.samsung.com/lv">www.samsung.com/lv</a>			
ESTONIA	800-7267	<a href="http://www.samsung.ee">www.samsung.ee</a>			

ⓔ Ⓢ ⓕ ⓐ ⓓ ⓖ Ⓝ ⓔ ⓑ ⓗ ⓞ Ⓡ DB98-29823A(2)



## Cassette Type Series

1 Way/Slim 1 Way cassette

2 Way cassette

4 Way/mini 4 Way cassette

# Air Conditioner user manual

imagine the possibilities

Thank you for purchasing this Samsung product.  
To receive more complete service, please  
register your product at

[www.samsung.com/global/register](http://www.samsung.com/global/register)

